



WS500 QUICK START GUIDE

WWW.WAKESPEED.COM



CHARGE SMARTER

WAKESPEED CONFIGURATION APP



CONFIGURING REGULATOR WITH DIP SWITCHES

The WS500 Alternator Regulator provides an extensive level of configuration via the Wakespeed Configuration App for Android and Apple OS smartphones and tablets. When the recommended Smartphone configuration is not an option, onboard DIP switches are available. With these, you can select one of eight preset battery programs to match your battery type, identify the battery being charged, define battery capacity and toggle between small and large alternator modes. Please refer to the online User Guide for further reference.

SELECTING BATTERY ID

The Battery ID provides a designator for the battery being monitored by the WS500 alternator regulator. Used in CAN connected systems.



1OFF/2OFF
House Battery



1ON/2OFF
Main Starter

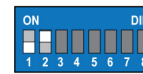

1OFF/2ON
Secondary House

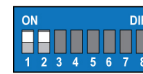

1ON/2ON
Other

SELECTING CHARGE PROFILES

The WS500 offers the ability to select from one of eight charging profiles based on battery types being charged, including two customizable profiles which can be configured on a PC via the regulator's USB port. Refer to the online User's Guide for detailed profile values and configuration instructions.



3OFF/4OFF/5OFF
Default, AGM#1



3ON/4OFF/5OFF
Std. FLA



3OFF/4ON/5OFF
Deep Cycle FLA

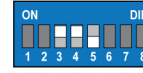

3ON/4ON/5OFF
High Density AGM



3OFF/4OFF/5ON
Gel



3ON/4OFF/5ON
Battle Born



3OFF/4ON/5ON
Custom #1

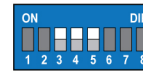

3ON/4ON/5ON
Custom #2 LiFePO4

DEFINING BATTERY CAPACITY

Provides configurability based on the size of the battery bank being charged. Four capacity levels shown at right.



6OFF/7OFF
< 250Ah



6ON/7OFF
250Ah-500Ah



6OFF/7ON
500Ah - 750Ah

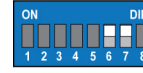

6ON/7ON
> 750Ah

SMALL/LARGE ALTERNATOR (FULLOUTPUT) MODES

Small Alternator Mode limits the maximum alternator output to 75% of maximum field potential and can be used to protect smaller alternators with larger battery loads and smaller engines and belts from excessive alternator horsepower loads. Note: DIP switch 8 will be the ONLY one to remain active if other DIP switches are overridden by a Windows or Smartphone configuration file. (Percentage adjustable via PC configuration. See online User Guide for details).



8 OFF
Large Alternator Mode

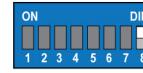

8 ON
Small Alternator Mode

LED STATUS / ADVISORY CODES

An onboard LED, visible on the lid of the WS500 Alternator Regulator indicates operational and diagnostic codes during operation. There are three modes of information: Standard Operation (green), Error/Advisory mode (red), and Sync Mode (when the regulator is responding to a dominant regulator or a BMS via CAN bus) indicated by a yellow/orange LED pattern. Error messages are preceded by two rapid bursts of red. The error message itself is two groups of steady red flashes, each indicating a numeric value. See the WS500 Communication and programming Guide for a detailed list of diagnostic messages. LED blink patterns are described below:

IDLE		Short Flash/Long Delay (4 sec.)
RAMP TO BULK		Short Flash/Short Delay (1/4 sec.)
ACCEPTANCE		Flash/Flash/Long Delay (4 sec.)
OVER CHARGE		Equal Flash/Delay (4 sec.)
FLOAT/POST FLOAT		Equal Long Flash/Delay (4 sec.)
EQUALIZE		Short Flash/Flash/Long Delay (4 sec.)
ERROR*		Equal Long Flash/Delay (4 sec.)
RESTARTING		Equal Flash/Delay (4 sec.)

*Error pattern repeated twice, followed by flashing of Error ID #. See reference guide for details



WS500

QUICK START GUIDE

WWW.WAKESPEED.COM



CHARGE SMARTER

WAKESPEED CONFIGURATION APP

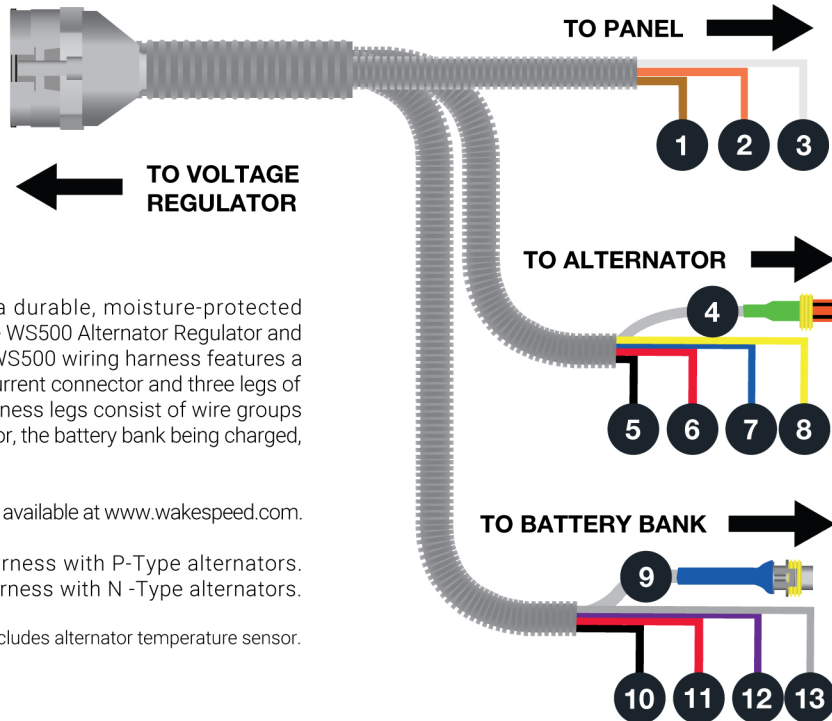

Designed to provide a durable, moisture-protected connection between the WS500 Alternator Regulator and the electrical system, WS500 wiring harness features a rugged Ampseal high-current connector and three legs of tinned marine wire. Harness legs consist of wire groups destined for the alternator, the battery bank being charged, and the dash panel.

A detailed User's Guide is available at www.wakespeed.com.

Use the WS500-PH harness with P-Type alternators.
Use the WS500-NH harness with N-Type alternators.

NOTE: Harness package includes alternator temperature sensor.

- 1 Ignition Wire (Brown)** Connects to switched voltage source (key switch or oil pressure switch). Must see zero volts when off and minimum of 8.5 VDC to activate.
- 2 Lamp/Feature Out Wire (Orange)** Remains neutral during normal regulator operation, and provides a source of ground to drive warning lamp or alarm if faults are detected. See User Guide for details.
- 3 Feature In Wire (White)** Can be connected to a voltage source greater than 8.5 VDC to enable a range of selectable optional capabilities as detailed in the User's Guide.
- 4 Alternator Temperature Sensor (Terminated in two-pin Superseal type connector with green heat shrink.)** Connects to 18" sensor pigtail included with harness. Connect sensor lug to alternator ground post or case bolt.
- 5 Alternator Ground (Black)** Connects to alternator ground post or to primary ground bus.
- 6 Alternator Positive (Red)** Connects to primary positive bus, or power post on alternator side of any switches or fusing. See WS500 User's Guide for detailed wiring diagrams. Fuse wire at 15 amps.
- 7 Alternator Field (Blue)** Connects to alternator's external field terminal.
- 8 Stator (Yellow)** Can be spliced into the alternator's tach output wire, or attached to alternator's AC/stator tap to enable regulator to determine low alternator RPM.
- 9 Battery Temperature Cable (Grey two-wire cable. Blue cable shrink.)** Provides a connection point for optional battery temperature sensor. Battery Temperature Sensor (WS500-BTS-K) sold separately.
- 10 Battery Ground Sense* (Black/Yellow Stripe)** Connects to alternator ground post or to primary ground bus.
- 11 Battery Positive Sense* (Red/Yellow Stripe)** Connects to primary positive bus, or power post on alternator side of any switches or fusing. See WS500 User's Guide for detailed wiring diagrams. Fuse wire at 3 amps.
- 12 Current Sensing** (+) (Purple)** Connects to low current machine screw on the side of the current shunt, closest to source of current. See mounting diagram in the WS500 User's Guide. Wire must be fused at 5A if shunt is located in the positive cable to batteries.
- 13 Current Sensing** (-) (Grey)** Connects to low current machine screw on the side of the current shunt, furthest from source of current. See mounting diagram in the WS500 User's Guide. Wire must be fused at 5A if shunt is located in the positive cable to batteries.

* Mounting location of power and voltage sense wires may vary based on individual application. See WS500 User's Guide for wiring diagrams. Note that both power (RED) and voltage sense (RED/YELLOW) must be installed on the alternator side of any switches or fusing in the DC charging circuit.

** Current sensing is calibrated for a 500A/50mV (default) current shunt. Installation may depend on whether shunt is installed HIGH or LOW. Refer to User's Guide for recommendations.